

**CEILING FAN INSTALLATION
AND OPERATION MANUAL
(MODEL NUMBER:AC-22656)**

READ AND SAVE THESE INSTRUCTIONS

SAFETY PRECAUTIONS

WARNING-INSTALLATION SHOULD BE PERFORMED BY A QUALIFIED ELECTRICIAN

1. To ensure the success of the installation, be sure to read the instructions and review the diagrams thoroughly before beginning.
2. All electrical connections must be in accordance with local codes, ordinances or National Electrical Code. If you are unfamiliar with methods of installing electrical wiring secure the services of a qualified electrician.
3. Make sure that your installation will not allow rotating fan blades to come in contact with any object.
4. If you are installing more than one ceiling fan, make sure that you do not mix fan blade sets.
5. Only mount fan to outlet box marked acceptable for ceiling fan.
6. Installation to a concrete ceiling should be performed by a qualified electrician.
7. Before beginning, disconnect power by removing fuse or turning off circuit breaker.
8. After fan is completely installed, make sure that all connections are secured to prevent fan from falling.
9. Do not insert anything into the fan blades while ceiling fan is operating.
10. The fan must be mounted with the blades at least 2.1m from the floor to minimum the possibility of accidental contact with the fan blades.
11. The supply wires Live & Neutral must be connected to wall switch (double poles) having a contact separation at least 3mm in all poles.

NOTE : The import safeguards and instructions appearing in the manual are not meant to cover all possible conditions and situations that may occur. It must be understood that common sense. Caution and carefulness are factors which cannot be built into any product. These factors must be supplied by the person(s) caring for and operating the unit.

WARNING

To reduce the risk of personal injury, do not bend the blades when installing the blades, balancing the blades or cleaning the fan. Do not insert foreign objects between rotating fan blades.

WARNING

The box must be supported directly by the building structure. The box and its support must be able support the fan weight - must not twist or work loose. Do not use plastic boxes.

Putting Your Fan Together

1. Remove the hairpin clip & washer from the clevis pin and remove clevis pin from down rod. (see Fig.1)
2. Insert the down rod through the center opening in the canopy, coupling cover and route the motor leads through the hanger ball/downrod assembly. Align the clevis pin holes in the downrod with the holes in the motor coupling. The clevis pin must pass through the holes in the motor coupling and the downrod. Place the washer onto the clevis pin and install the hairpin clip making sure to push straight leg of the hairpin clip through the hole near hanger ball to make sure the clevis pin is properly installed(see Fig.2)
3. Reinstall the 2 set screws in the motor coupling and securely tighten set screws against the down rod assembly.

Installing Blade Assembly

Attached each blade assembly to the center band using the blade screws and blade washers. Tighten them securely.(see Fig.3& 4)

Caution: To reduce the risk of personal injury. Do not bend the blade when installing, balancing or cleaning the fan. Do not insert foreign objects between rotating fan blades.

Hanging Your Ceiling Fan

1. Securely attach the hanger bracket to the outlet box by washers and screws supplied. Connect white wire from ceiling to white wire from receiver with wire nut. Connect black wire from ceiling to black wire from receiver with wire nut. (see Fig.5)
2. Carefully lift the fan and seat the down rod ball assembly on the hanger bracket. Be sure the groove in the ball is lined up with tab on the hanger bracket. Do not pinch wires between the ball and down rod assembly and hanger bracket (see Fig.6)
3. Install the safety cable into the building structure. (see Fig.7)

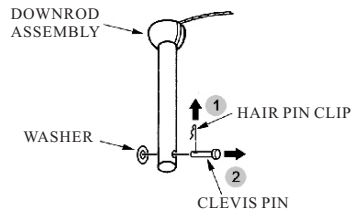

FIG.1

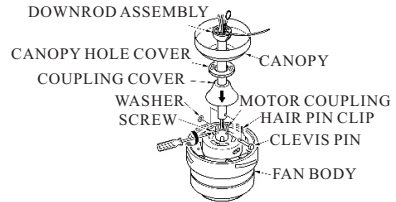

FIG.2

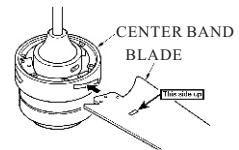

FIG.3

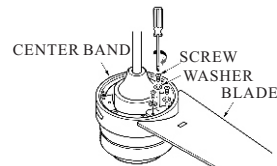

FIG.4

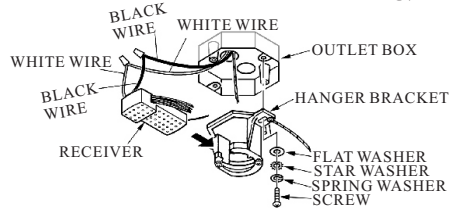

FIG.5

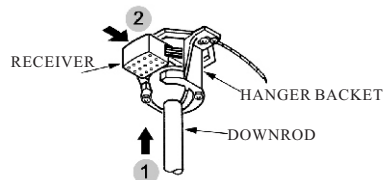

FIG.6

Wiring Your Ceiling Fan

Caution: To avoid possible electrical shock, be sure electricity is turned off at the main fuse box before wiring.

1. If you are not sure that the electrical box is grounded, contact a licensed electrician for advice. It must be grounded for safe operation.
2. Connect the white wire from receiver to the white wire from fan with wire nut. Connect the black wire from receiver to the black wire from fan with wire nut. Connect the blue wire from receiver to the blue wire from fan with wire nut. Connect the green wire from ceiling, and green wire from hanger bracket with green wire from downrod ball with wire nut. (see Fig.8)
3. Remove one of screws and loosen the other screw from the hanger bracket. (see Fig.9)
4. Mount the canopy on the hanger bracket and tighten the screws. (see Fig.10)
5. Place the canopy hole cover over the screws and twist the cover to tighten. (see Fig.11)

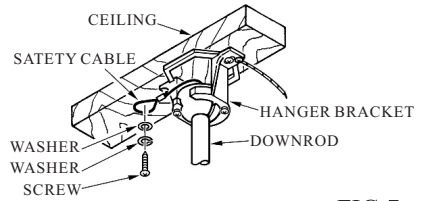

FIG.7

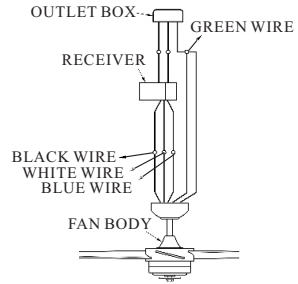

FIG.8

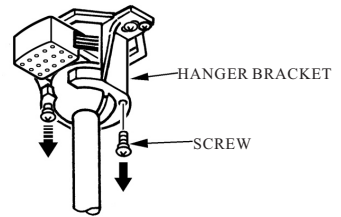

FIG.9

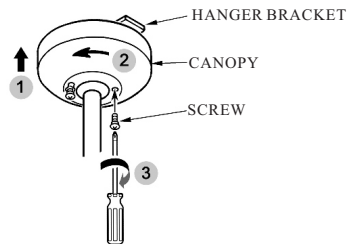

FIG.10

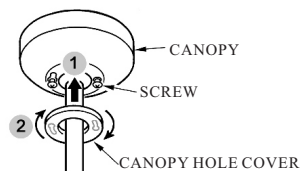

FIG.11

Installing The Light Kit

1. Remove 3 screws on light kit adapter, (See Fig.12)
2. Lift the light kit plate onto the light kit adapter and align the three holes on light kit plate with the light kit adapter. Tighten back the 3 removed screws. (See Fig 13)
3. Remove 3 screws on light kit plate. (see Fig. 14)
4. Plug together light kit wires from fan to light kit wires from LED light (see Fig.15)
5. Tighten the light kit by using the 3 screws removed in step 3 (see Fig.16)
6. Attach the PC shade by locating tabs in light kit with grooves on the light shade and twist clockwise until tight (see Fig.17)

Fan Airflow Direction

Slide the reverse switch to right or left to obtain opposite direction of airflow. (See Fig.18)

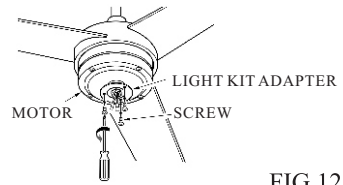

FIG.12

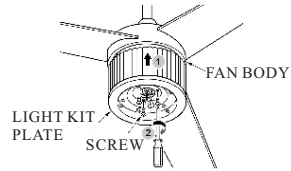

FIG.13

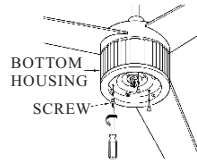

FIG.14

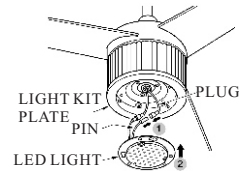

FIG.15

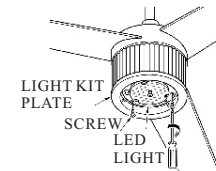

FIG.16

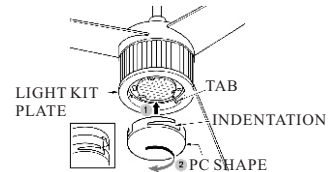

FIG.17

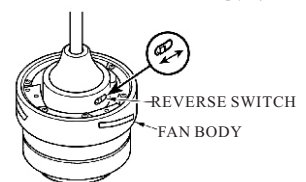
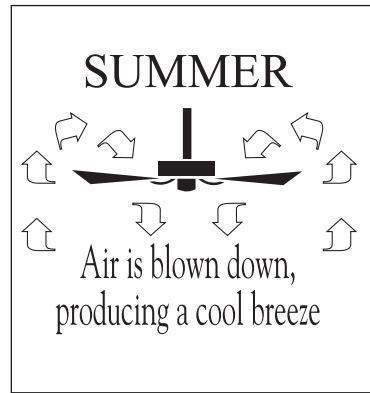

FIG.18

Operation in Summer

In warm weather, the reverse switch should be set to produce a downward flow of air. The constant, gentle breeze will transfer heat from your body; thus, you will feel cooler even if the temperature remains unchanged. This cooling effect is referred to as a wind-chill factor. In an air-conditioned home, the wind-chill factor will allow you to set the thermostat higher than the usual setting. While using less energy to air-condition your home, you will stay just as cool.

For summer cooling, set the speed control on medium or fast speed. This will provide sufficient airflow to accomplish a cooling effect. The exception to this is in bedrooms where a brisk, downward flow would be too chilly. A low-speed, gentle breeze is all that is necessary to keep you comfortable at night.



Operating in Winter

Winter comfort requires a different approach. Because warm air rises the air close to the ceiling is always warmer-by perhaps 15 degrees-than the air close to the floor. To prevent heat from hovering where it does little good, move the reverse switch to create an upward airflow. This will pull cool air up and force warm air across the ceiling and down the walls. Set the variable speed control fast enough to break up the air stratification, but slow enough not to create a draft. By keeping the heat circulating, the heater will not have to operate as often to keep you warm.

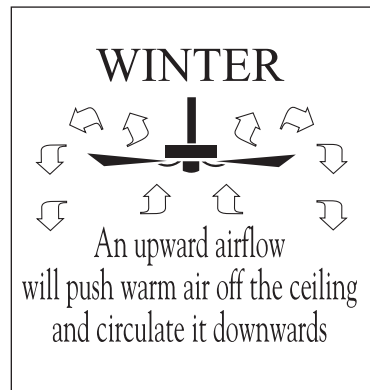

CARE OF YOUR FAN

Here are some suggestions to help you maintain your fan.

1. Because of the fan's natural movement, some connections may become loose. Check the support connections, brackets, and blade attachments twice a year. Make sure they are secure. (It is not necessary to remove fan from ceiling.)
2. Clean your fan periodically to help maintain its new appearance over the years. Use only a soft brush or lint-free cloth to avoid scratching the finish. The plating is sealed with a lacquer to minimize discoloration or tarnishing. Do not use water when cleaning. This could damage the motor, or the wood, or possibly cause an electrical shock.
3. You can apply a light coat of furniture polish to the wood blades for additional protection and enhanced beauty. Cover small scratches with a light application of shoe polish.
4. There is no need to oil your fan. The motor has permanently lubricated sealed ball bearings.

TROUBLESHOOTING

Problem	Solution
Fan will not start.	<ol style="list-style-type: none">1. Check main and branch circuit fuses or breakers.2. Check line wire connections to the fan and switch wire connections in the switch housing.3. Check to make sure the dip switches from the transmitter and receiver are set to the same frequency.
Fan sounds noisy.	<ol style="list-style-type: none">1. Make sure all motor housing screws are snug.2. Make sure the screws that attach the fan blade bracket to the motor hub are tight.3. Make sure wire nut connections are not rattling against each other or the interior wall of the switch housing.4. Allow a 24-hour "breaking-in" period. Most noises associated with a new fan disappear during this time.5. If using ceiling fan light kit, make sure the screws securing the glassware are tight. Check that the light bulb is also secure.6. Make sure there is a short distance from the ceiling to the canopy. It should not touch the ceiling.7. Make sure your ceiling box is secure and rubber isolator pads are used between mounting bracket and outlet box.
Remote control malfunction.	<ol style="list-style-type: none">1. Do not connect the fan with a wall mounted variable speed control(s).2. Make sure the dip switches are set correctly.
Lights shut off and will not come back on.	<ol style="list-style-type: none">1. This unit may be equipped with a wattage limiting device. Lamping in excess of 190 watts will disable your ceiling fan's light kit. To reset your light kit you must turn the power off and relamp, keeping the wattage under 190 watts. Restore power to your ceiling fan and continue normal operation.
Fan wobble.	<ol style="list-style-type: none">1. Check that all blade and blade arm screws are secure.2. Most fan wobbling problems are caused when blade levels are unequal. Check this level by selecting a point on the ceiling above the tip of one of the blades. Measure this distance. Rotate the fan until the next blade is positioned for measurement. Repeat for each blade. The distance deviation should be equal within 1/8".3. Use the enclosed Blade Balancing Kit if the blade wobble is still noticeable.4. If the blade wobble is still noticeable, interchanging two adjacent (side by side) blades can redistribute the weight and possibly result in smoother operation.

WARNING: TO REDUCE THE RISK OF PERSONAL INJURY, DO NOT BEND THE BLADE ARM WHILE INSTALLING, BALANCING THE BLADES, OR CLEANING THE FAN. DO NOT INSERT FOREIGN OBJECTS BETWEEN ROTATING FAN BLADES.

CEILING FAN WALL TRANSMITTER CONTROLLER

WARNING! SHUT OFF THE POWER WITH FUSE OR CIRCUIT BREAKER.

1. SAFETY PRECAUTIONS:

- **WARNING: HIGH VOLTAGE:** Disconnect the electric power source by removing fuse or switching off circuit breakers.
- Do not use with solid state fans.
- Electrical wiring must meet all local and national electrical code requirements.
- Electrical source and fan must be 115/120 volt, 60Hz. Maximum fan motor 1A, Maximum light watts: 60W LED only.
- Household electric power can cause serious injury or death.

2. FREQUENCY INTERFERENCE.

- Turn the power off to your ceiling fan.
- Return power to the receiver.
NOTE: After the AC power is on, do not press any other button on the wall transmitter before pressing the "SET" button (in the small plate), doing so will cause the procedure to fail. (Fig.1)
- Within 60 seconds of turning the fan's AC power on, Press and hold the transmitter's "SET" button for 3 seconds.
- Once the receiver has detected the set frequency, the light of your fan if applicable will blink twice. (There is no indication if your fan is not equipped with a light)
- The receiver has now learn the frequency with the wall transmitter. After completing the steps above, you should be able to operate the ceiling fan and light. If the fan is not responding to the transmitter, Please turn the power off to the receiver, and repeat the process.

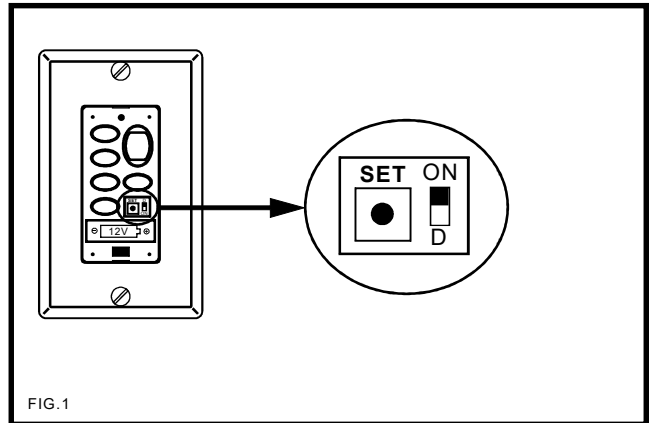

3. INSTALLING THE RECEIVER

- Remove the ceiling fan canopy from the mounting bracket.
- Disconnect the existing wiring between ceiling fan and the junction box.

4. CONNECTING THE RECEIVER (FIG.2)

- Use the wire nuts provided and make electrical connections as follows:
- Connect Green wire from fan to the Bare copper (ground) from junction box.
 - Connect Black wire (AC IN L) from the Receiver to the Black wire from the junction box.
 - Connect White wire (AC IN N) from the Receiver to the White wire from junction box.
 - Connect Black wire (TO MOTOR L) from the Receiver to the Black wire from fan.
 - Connect White wire (TO MOTOR N) from the Receiver to the White wire from fan.
 - Connect Blue wire (FOR LIGHT) from the Receiver to the Blue wire from fan.
 - After wires are connected, carefully tuck them into the junction box.
 - Lay the black antenna wire on top of the Receiver and insert into the mounting bracket.
 - Reinstall the canopy onto the mounting bracket.

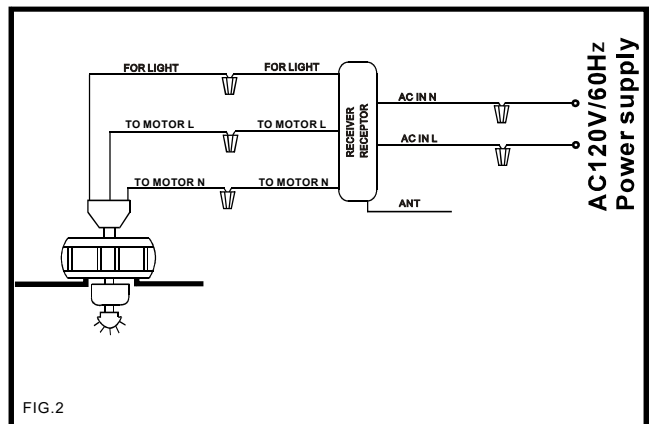

5. INSTALLING THE WIRELESS WALL TRANSMITTER (FIG.3)

- Remove the existing wall plate and switch. Be sure to complete the electrical circuit within the junction box by passing wall control. Connect black to black, white to white, green to green. Carefully push wires into the outlet box.
- Attach wall control unit to outlet box using the two #8-32 screws provided.
- Attach wall plate to the switch control front using the two small screws provided.

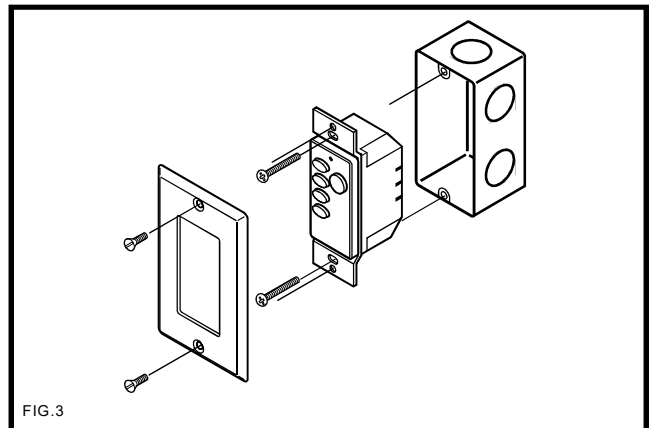

6. INSTALLING THE BATTERY INTO THE TRANSMITTER (FIG.4)

Remove the small panel on the front of the transmitter and insert the battery provided. Make sure the "+" "-" sign is correct. (FIG.3)
NOTE: Use 1x12V (23A) battery. If not using for long period of time, remove battery to prevent damage to transmitter.

7. OPERATING THE TRANSMITTER

- "HI" button: this button used to select the fan at high speed.
- "MED" button: this button used to select the fan at medium speed.
- "LOW" button: this button used to select the fan at low speed.
- "OFF" This button will turn the fan off.
- "LIGHT" This button will turn the light on or off and will also control the brightness setting. Press and release the button and the light will turn on or off. Press and hold the button for the desired brightness. The light will cycle continuously between bright and dim settings as long as the button is held down. The light key has auto resume, it will stay at the same brightness as last time when it was turned off.
- Memory function
If you turn off the fan or light by wall control, it will memorize and recover automatically to last time's fan speed and light brightness when turned on next time.
- Light on/off and dimmer select.
There is a dip switch in the plate. (fig 1), this switch used to select the light mode. If this switch select "D", The light in the dimming mode. If this switch select "ON", the light in the "ON/OFF" mode.

8. RECEIVER PROTECTIVE FUNCTIONS

- Over load protection (current limit)- The device limits the maximum current output from the receiver/drive when the fan or light load is increased abnormally. The fan will shut off if over lamped.

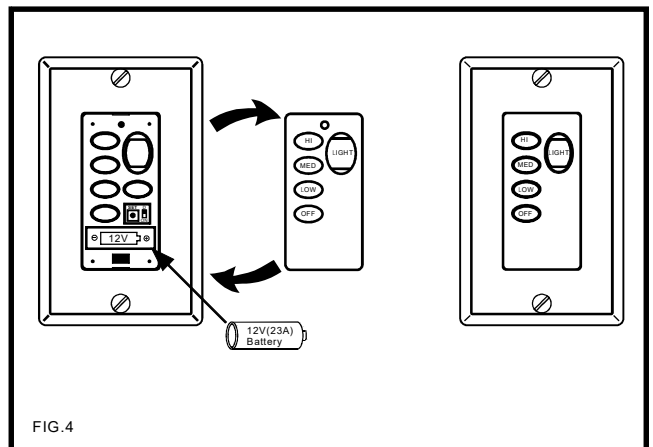

NOTE: This device complies with part 15 of the FCC rules. Operation is subject to the following two conditions:
(1) This device may not cause harmful interference;
(2) This device must accept any interference received, including interference that may cause undesired operation.