

# TRACK CORNER INSTRUCTIONS

## MSAS03 "L" CORNER

### ACCESSORIES REQUIRED:

KENDAL MODEL MSAS03



WHICH INCLUDES: 2 × MSA PINS



2 × MSA02 CONNECTORS



KENDAL MODEL MSA01 POWER PLATE IF REQUIRED



### DIMENSIONS

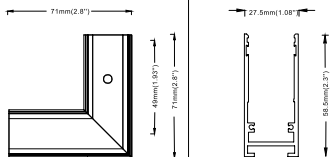

### STEP 1 REMOVE END CAP FROM TRACK

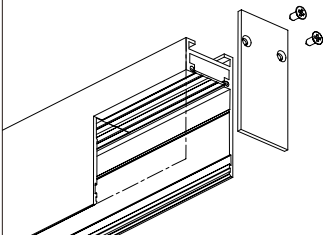

**STEP 2 REMOVE DECORATIVE PLATE, IF CONNECTING TO END OF TRACK THAT DOES NOT HAVE A DECORATIVE PLATE SKIP TO STEP 5.**

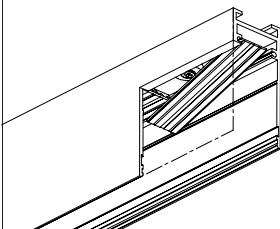

### STEP 3 REMOVE MAGNET

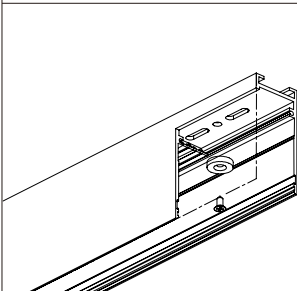

### STEP 4 INSERT THE MSA01 POWER PLATE (d) - SOLD SEPARATELY

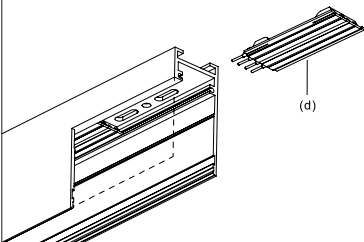

**STEP 5 INSTALL THE MSA22 PIN SET (b) INTO THE PIN CONNECTOR HOLES (c) ON THE TRACK. SLIDE THE TRACK CONNECTOR (a) INTO THE SLOT ON THE BACK OF THE TRACK APPROXIMATELY HALFWAY AND SECURE TO TRACK WITH TWO SET SCREWS.**

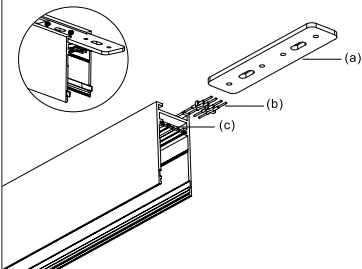

**STEP 6** SLIDE MSA803 TRACK CORNER ONTO THE TRACK CONNECTOR (a) WHILE CAREFULLY LINING UP THE PIN SET ON THE TRACK WITH THE PIN SET HOLES ON THE TRACK CORNER.

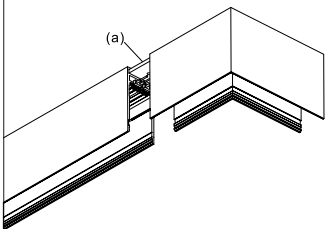

**ATTENTION:**

WHEN JOINING TRACKS OR ACCESSORIES UTILIZING PIN CONNECTORS, MAKE SURE PINS ARE HORIZONTAL AND LINE UP WITH PIN CONNECTOR HOLES. YOU MAY NEED TO GENTLY PUSH UP OR DOWN ON THE PINS SO THEY LINE UP CORRECTLY. FAILING TO DO THIS MAY RESULT IN PINS MISSING THE PIN CONNECTOR HOLES AND LOSS OF THE 24 VOLT CONNECTION.

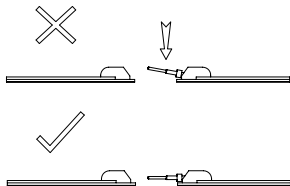

**STEP 7** SECURE OTHER END OF TRACK CONNECTOR (a) TO THE TRACK CORNER WITH REMAINING TWO SET SCREWS

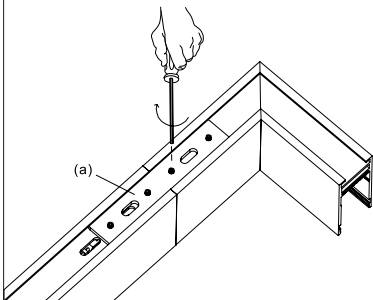

**STEP 8** REPEAT STEPS 1 THROUGH 7 FOR OTHER SIDE OF TRACK CORNER AND COMPLETE TRACK CORNER CONNECTION.

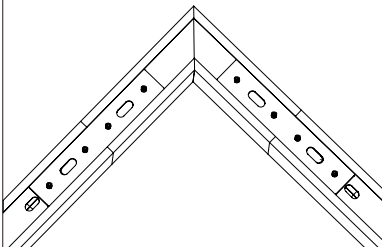

**NOTE:**

AFTER EACH TRACK CONNECTION A CONTINUITY TEST SHOULD BE DONE TO ENSURE PROPER ELECTRICAL CONNECTIONS WERE MADE.